

The Data Book Project

DatasheetArchive.com has launched an ambitious effort to digitize thousands of obsolete data books and technical manuals, making them searchable via the DatasheetArchive website.

Scroll down to see the scanned document.



8085A/8085A-2 SINGLE CHIP 8-BIT N-CANNEL MICROPROCESSORS

- Single +5V Power Supply
- 100% Software Compatible with 8080A
- 1.3 μ s Instruction Cycle (8085A);
0.8 μ s (8085A-2)
- On-Chip Clock Generator (with External Crystal, LC or RC Network)
- On-Chip System Controller; Advanced Cycle Status Information Available for Large System Control
- Four Vectored Interrupt Inputs (One is Non-Maskable) Plus an 8080A-Compatible Interrupt
- Serial In/Serial Out Port
- Decimal, Binary and Double Precision Arithmetic
- Direct Addressing Capability to 64k Bytes of Memory

The Intel® 8085A is a complete 8 bit parallel Central Processing Unit (CPU). Its instruction set is 100% software compatible with the 8080A microprocessor, and it is designed to improve the present 8080A's performance by higher system speed. Its high level of system integration allows a minimum system of three IC's [8085A (CPU), 8156 (RAM/IO) and 8355/8755A (ROM/PROM/IO)] while maintaining total system expandability. The 8085A-2 is a faster version of the 8085A.

The 8085A incorporates all of the features that the 8224 (clock generator) and 8228 (system controller) provided for the 8080A, thereby offering a high level of system integration.

The 8085A uses a multiplexed data bus. The address is split between the 8 bit address bus and the 8 bit data bus. The on-chip address latches of 8155/8156/8355/8755A memory products allow a direct interface with the 8085A.

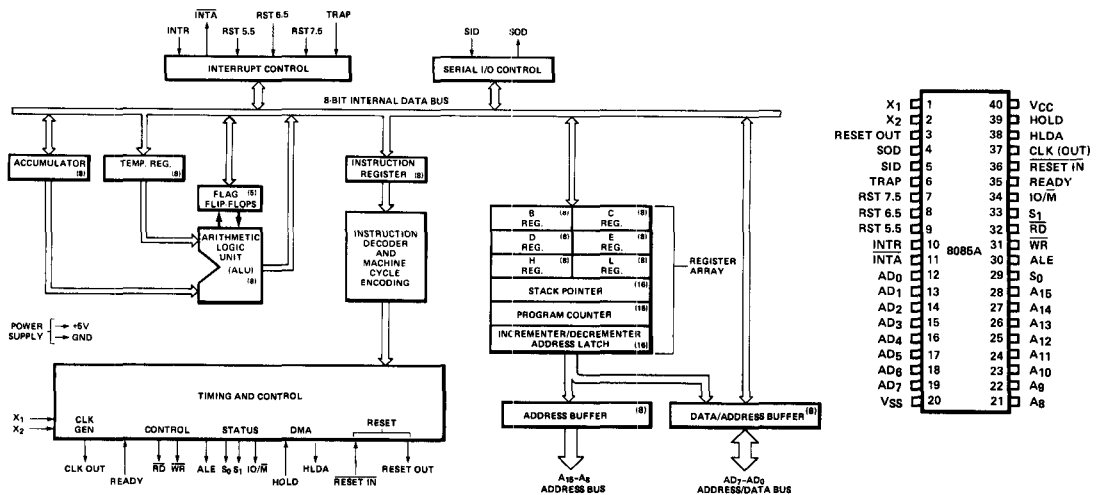

Figure 1. 8085A CPU Functional Block Diagram

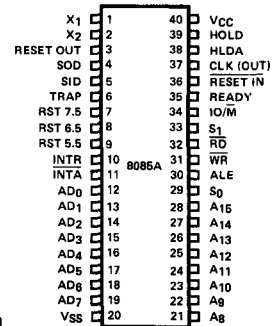

Figure 2. 8085A Pin Configuration

Table 1. Pin Description

Symbol	Type	Name and Function	Symbol	Type	Name and Function																																												
A ₈ -A ₁₅	O	Address Bus: The most significant 8 bits of the memory address or the 8 bits of the I/O address, 3-stated during Hold and Halt modes and during RESET.	READY	I	Ready: If READY is high during a read or write cycle, it indicates that the memory or peripheral is ready to send or receive data. If READY is low, the cpu will wait an integral number of clock cycles for READY to go high before completing the read or write cycle. READY must conform to specified setup and hold times.																																												
AD ₀ -7	I/O	Multiplexed Address/Data Bus: Lower 8 bits of the memory address (or I/O address) appear on the bus during the first clock cycle (T state) of a machine cycle. It then becomes the data bus during the second and third clock cycles.	HOLD	I	Hold: Indicates that another master is requesting the use of the address and data buses. The cpu, upon receiving the hold request, will relinquish the use of the bus as soon as the completion of the current bus transfer. Internal processing can continue. The processor can regain the bus only after the HOLD is removed. When the HOLD is acknowledged, the Address, Data RD, WR, and IO/M lines are 3-stated.																																												
ALE	O	Address Latch Enable: It occurs during the first clock state of a machine cycle and enables the address to get latched into the on-chip latch of peripherals. The falling edge of ALE is set to guarantee setup and hold times for the address information. The falling edge of ALE can also be used to strobe the status information. ALE is never 3-stated.	HLDA	O	Hold Acknowledge: Indicates that the cpu has received the HOLD request and that it will relinquish the bus in the next clock cycle. HLDA goes low after the Hold request is removed. The cpu takes the bus one half clock cycle after HLDA goes low.																																												
S ₀ , S ₁ , and IO/M	O	<p>Machine Cycle Status:</p> <table border="1"> <thead> <tr> <th>IO/M</th> <th>S₁</th> <th>S₀</th> <th>Status</th> </tr> </thead> <tbody> <tr> <td>0</td> <td>0</td> <td>1</td> <td>Memory write</td> </tr> <tr> <td>0</td> <td>1</td> <td>0</td> <td>Memory read</td> </tr> <tr> <td>1</td> <td>0</td> <td>1</td> <td>I/O write</td> </tr> <tr> <td>1</td> <td>1</td> <td>0</td> <td>I/O read</td> </tr> <tr> <td>0</td> <td>1</td> <td>1</td> <td>Opcode fetch</td> </tr> <tr> <td>1</td> <td>1</td> <td>1</td> <td>Opcode fetch</td> </tr> <tr> <td>1</td> <td>1</td> <td>1</td> <td>Interrupt Acknowledge</td> </tr> <tr> <td>*</td> <td>0</td> <td>0</td> <td>Halt</td> </tr> <tr> <td>*</td> <td>X</td> <td>X</td> <td>Hold</td> </tr> <tr> <td>*</td> <td>X</td> <td>X</td> <td>Reset</td> </tr> </tbody> </table> <p>* = 3-state (high impedance) X = unspecified</p> <p>S₁ can be used as an advanced R/W status. IO/M, S₀ and S₁ become valid at the beginning of a machine cycle and remain stable throughout the cycle. The falling edge of ALE may be used to latch the state of these lines.</p>	IO/M	S ₁	S ₀	Status	0	0	1	Memory write	0	1	0	Memory read	1	0	1	I/O write	1	1	0	I/O read	0	1	1	Opcode fetch	1	1	1	Opcode fetch	1	1	1	Interrupt Acknowledge	*	0	0	Halt	*	X	X	Hold	*	X	X	Reset	INTR	I	Interrupt Request: Is used as a general purpose interrupt. It is sampled only during the next to the last clock cycle of an instruction and during Hold and Halt states. If it is active, the Program Counter (PC) will be inhibited from incrementing and an INTA will be issued. During this cycle a RESTART or CALL instruction can be inserted to jump to the interrupt service routine. The INTR is enabled and disabled by software. It is disabled by Reset and immediately after an interrupt is accepted.
IO/M	S ₁	S ₀	Status																																														
0	0	1	Memory write																																														
0	1	0	Memory read																																														
1	0	1	I/O write																																														
1	1	0	I/O read																																														
0	1	1	Opcode fetch																																														
1	1	1	Opcode fetch																																														
1	1	1	Interrupt Acknowledge																																														
*	0	0	Halt																																														
*	X	X	Hold																																														
*	X	X	Reset																																														
RD	O	Read Control: A low level on RD indicates the selected memory or I/O device is to be read and that the Data Bus is available for the data transfer, 3-stated during Hold and Halt modes and during RESET.	INTA	O	Interrupt Acknowledge: Is used instead of (and has the same timing as) RD during the instruction cycle after an INTR is accepted. It can be used to activate an 8259A interrupt chip or some other interrupt port.																																												
WR	O	Write Control: A low level on WR indicates the data on the Data Bus is to be written into the selected memory or I/O location. Data is set up at the trailing edge of WR. 3-stated during Hold and Halt modes and during RESET.	RST 5.5 RST 6.5 RST 7.5	I	<p>Restart Interrupts: These three inputs have the same timing as INTR except they cause an internal RESTART to be automatically inserted.</p> <p>The priority of these interrupts is ordered as shown in Table 2. These interrupts have a higher priority than INTR. In addition, they may be individually masked out using the SIM instruction.</p>																																												

Table 1. Pin Description (Continued)

Symbol	Type	Name and Function
TRAP	I	Trap: Trap interrupt is a non-maskable RESTART interrupt. It is recognized at the same time as INTR or RST 5.5-7.5. It is unaffected by any mask or Interrupt Enable. It has the highest priority of any interrupt. (See Table 2.)
RESET IN	I	Reset In: Sets the Program Counter to zero and resets the Interrupt Enable and HLDA flip-flops. The data and address buses and the control lines are 3-stated during RESET and because of the asynchronous nature of RESET, the processor's internal registers and flags may be altered by RESET with unpredictable results. RESET IN is a Schmitt-triggered input, allowing connection to an R-C network for power-on RESET delay. The cpu is held in the reset condition as long as RESET IN is applied.

Symbol	Type	Name and Function
RESET OUT	O	Reset Out: Reset Out indicates cpu is being reset. Can be used as a system reset. The signal is synchronized to the processor clock and lasts an integral number of clock periods.
X ₁ , X ₂	I	X₁ and X₂: Are connected to a crystal, LC, or RC network to drive the internal clock generator. X ₁ can also be an external clock input from a logic gate. The input frequency is divided by 2 to give the processor's internal operating frequency.
CLK	O	Clock: Clock output for use as a system clock. The period of CLK is twice the X ₁ , X ₂ input period.
SID	I	Serial Input Data Line: The data on this line is loaded into accumulator bit 7 whenever a RIM instruction is executed.
SOD	O	Serial Output Data Line: The output SOD is set or reset as specified by the SIM instruction.
V _{CC}		Power: +5 volt supply.
V _{SS}		Ground: Reference.

Table 2. Interrupt Priority, Restart Address, and Sensitivity

Name	Priority	Address Branched To (1) When Interrupt Occurs	Type Trigger
TRAP	1	24H	Rising edge AND high level until sampled.
RST 7.5	2	3CH	Rising edge (latched).
RST 6.5	3	34H	High level until sampled.
RST 5.5	4	2CH	High level until sampled.
INTR	5	See Note (2).	High level until sampled.

NOTES:

1. The processor pushes the PC on the stack before branching to the indicated address.
2. The address branched to depends on the instruction provided to the cpu when the interrupt is acknowledged.

FUNCTIONAL DESCRIPTION

The 8085A is a complete 8-bit parallel central processor. It is designed with N-channel depletion loads and requires a single +5 volt supply. Its basic clock speed is 3 MHz (8085A) or 5 MHz (8085A-2), thus improving on the present 8080A's performance with higher system speed. Also it is designed to fit into a minimum system of three IC's: The cpu (8085A), a RAM/IO (8156), and a ROM or EPROM/IO chip (8355 or 8755A).

The 8085A has twelve addressable 8-bit registers. Four of them can function only as two 16-bit register pairs. Six others can be used interchangeably as 8-bit registers or as 16-bit register pairs. The 8085A register set is as follows:

Mnemonic	Register	Contents
ACC or A	Accumulator	8 bits
PC	Program Counter	16-bit address
BC,DE,HL	General-Purpose Registers; data pointer (HL)	8 bits x 6 or 16 bits x 3
SP	Stack Pointer	16-bit address
Flags or F	Flag Register	5 flags (8-bit space)

The 8085A uses a multiplexed Data Bus. The address is split between the higher 8-bit Address Bus and the lower 8-bit Address/Data Bus. During the first T state (clock cycle) of a machine cycle the low order address is sent out on the Address/Data bus. These lower 8 bits may be latched externally by the Address Latch Enable signal (ALE). During the rest of the machine cycle the data bus is used for memory or I/O data.

The 8085A provides \overline{RD} , \overline{WR} , S_0 , S_1 , and IO/\overline{M} signals for bus control. An Interrupt Acknowledge signal (\overline{INTA}) is also provided. HOLD and all Interrupts are synchronized with the processor's internal clock. The 8085A also provides Serial Input Data (SID) and Serial Output Data (SOD) lines for simple serial interface.

In addition to these features, the 8085A has three maskable, vector interrupt pins and one nonmaskable TRAP interrupt.

INTERRUPT AND SERIAL I/O

The 8085A has 5 interrupt inputs: INTR, RST 5.5, RST 6.5, RST 7.5, and TRAP. INTR is identical in function to the 8080A INT. Each of the three RESTART inputs, 5.5, 6.5, and 7.5, has a programmable mask. TRAP is also a RESTART interrupt but it is nonmaskable.

The three maskable interrupts cause the internal execution of RESTART (saving the program counter in the stack and branching to the RESTART address) if the interrupts are enabled and if the interrupt mask is not set. The non-maskable TRAP causes the internal execution of a RESTART vector independent of the state of the interrupt enable or masks. (See Table 2.)

There are two different types of inputs in the restart interrupts. RST 5.5 and RST 6.5 are *high level-sensitive* like INTR (and INT on the 8080) and are recognized with the same timing as INTR. RST 7.5 is *rising edge-sensitive*.

For RST 7.5, only a pulse is required to set an internal flip-flop which generates the internal interrupt request. (See Section 5.2.7.) The RST 7.5 request flip-flop remains

set until the request is serviced. Then it is reset automatically. This flip-flop may also be reset by using the SIM instruction or by issuing a $\overline{RESET IN}$ to the 8085A. The RST 7.5 internal flip-flop will be set by a pulse on the RST 7.5 pin even when the RST 7.5 interrupt is masked out.

The status of the three RST interrupt masks can only be affected by the SIM instruction and $\overline{RESET IN}$. (See SIM, Chapter 5.)

The interrupts are arranged in a fixed priority that determines which interrupt is to be recognized if more than one is pending as follows: TRAP — highest priority, RST 7.5, RST 6.5, RST 5.5, INTR — lowest priority. This priority scheme does not take into account the priority of a routine that was started by a higher priority interrupt. RST 5.5 can interrupt an RST 7.5 routine if the interrupts are re-enabled before the end of the RST 7.5 routine.

The TRAP interrupt is useful for catastrophic events such as power failure or bus error. The TRAP input is recognized just as any other interrupt but has the highest priority. It is not affected by any flag or mask. The TRAP input is both *edge and level sensitive*. The TRAP input must go high and remain high until it is acknowledged. It will not be recognized again until it goes low, then high again. This avoids any false triggering due to noise or logic glitches. Figure 3 illustrates the TRAP interrupt request circuitry within the 8085A. Note that the servicing of any interrupt (TRAP, RST 7.5, RST 6.5, RST 5.5, INTR) disables all future interrupts (except TRAPs) until an EI instruction is executed.

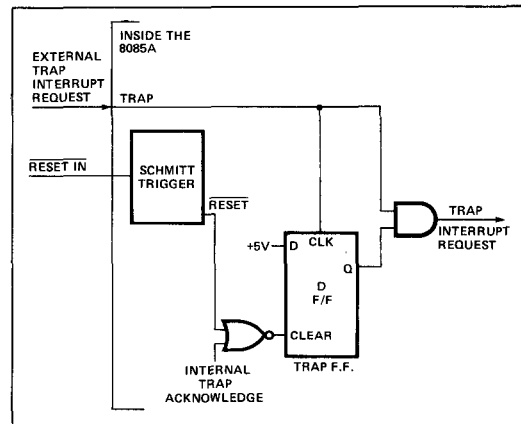

Figure 3. TRAP and RESET IN Circuit

The TRAP interrupt is special in that it disables interrupts, but preserves the previous interrupt enable status. Performing the first RIM instruction following a TRAP interrupt allows you to determine whether interrupts were enabled or disabled prior to the TRAP. All subsequent RIM instructions provide current interrupt enable status. Performing a RIM instruction following INTR, or RST 5.5-7.5 will provide current Interrupt Enable status, revealing that interrupts are disabled. See the description of the RIM instruction in Chapter 5.

The serial I/O system is also controlled by the RIM and SIM instructions. SID is read by RIM, and SIM sets the SOD data.

DRIVING THE X₁ AND X₂ INPUTS

You may drive the clock inputs of the 8085A or 8085A-2 with a crystal, an LC tuned circuit, an RC network, or an external clock source. The driving frequency must be at least 1 MHz, and must be twice the desired internal clock frequency; hence, the 8085A is operated with a 6 MHz crystal (for 3 MHz clock), and the 8085A-2 can be operated with a 10 MHz crystal (for 5 MHz clock). If a crystal is used, it must have the following characteristics:

Parallel resonance at twice the clock frequency desired

C_L (load capacitance) ≤ 30 pF

C_s (shunt capacitance) ≤ 7 pF

R_s (equivalent shunt resistance) ≤ 75 Ohms

Drive level: 10 mW

Frequency tolerance: ±.005% (suggested)

Note the use of the 20pF capacitor between X₂ and ground. This capacitor is required with crystal frequencies below 4 MHz to assure oscillator startup at the correct frequency. A parallel-resonant LC circuit may be used as the frequency-determining network for the 8085A, providing that its frequency tolerance of approximately ±10% is acceptable. The components are chosen from the formula:

$$f = \frac{1}{2\pi\sqrt{L(C_{ext} + C_{int})}}$$

To minimize variations in frequency, it is recommended that you choose a value for C_{ext} that is at least twice that of C_{int}, or 30 pF. The use of an LC circuit is not recommended for frequencies higher than approximately 5 MHz.

An RC circuit may be used as the frequency-determining network for the 8085A if maintaining a precise clock frequency is of no importance. Variations in the on-chip timing generation can cause a wide variation in frequency when using the RC mode. Its advantage is its low component cost. The driving frequency generated by the circuit shown is approximately 3 MHz. It is not recommended that frequencies greatly higher or lower than this be attempted.

Figure 4 shows the recommended clock driver circuits. Note in D and E that pullup resistors are required to assure that the high level voltage of the input is at least 4 V.

For driving frequencies up to and including 6 MHz you may supply the driving signal to X₁ and leave X₂ open-circuited (Figure 4D). If the driving frequency is from 6 MHz to 10 MHz, stability of the clock generator will be improved by driving both X₁ and X₂ with a push-pull source (Figure 4E). To prevent self-oscillation of the 8085A, be sure that X₂ is not coupled back to X₁ through the driving circuit.

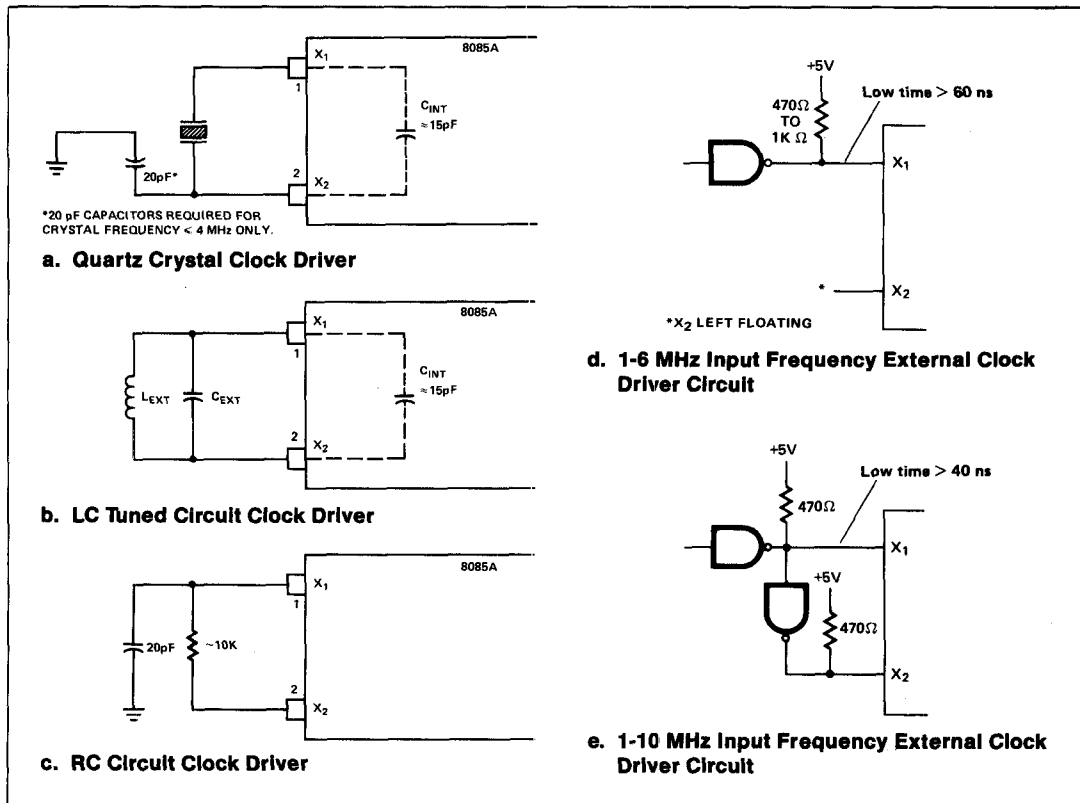

Figure 4. Clock Driver Circuits

GENERATING AN 8085A WAIT STATE

If your system requirements are such that slow memom or peripheral devices are being used, the circuit shown Figure 5 may be used to insert one WAIT state in ea 8085A machine cycle

The D flip-flops should be chosen so that

- CLK is rising edge-triggered
- CLEAR is low-level active.

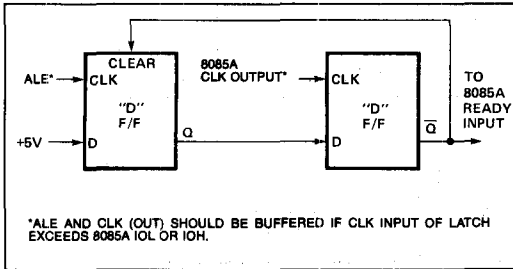

Figure 5. Generation of a Wait State for 8085A CPU

As in the 8080, the READY line is used to extend the read and write pulse lengths so that the 8085A can be used with slow memory. HOLD causes the cpu to relinquish the bus when it is through with it by floating the Address and Data Buses.

SYSTEM INTERFACE

The 8085A family includes memory components, which are directly compatible to the 8085A cpu. For example, a system consisting of the three chips, 8085A, 8156, and 8355 will have the following features:

- 2K Bytes ROM
- 256 Bytes RAM
- 1 Timer/Counter
- 4 8-bit I/O Ports
- 1 6-bit I/O Port
- 4 Interrupt Levels
- Serial In/Serial Out Ports

This minimum system, using the standard I/O technique is as shown in Figure 6.

In addition to standard I/O, the memory mapped I/O offers an efficient I/O addressing technique. With this technique, an area of memory address space is assigned for I/O address, thereby, using the memory address for I/O manipulation. Figure 7 shows the system configuration of Memory Mapped I/O using 8085A.

The 8085A cpu can also interface with the standard memory that does *not* have the multiplexed address/data bus. It will require a simple 8212 (8-bit latch) as shown in Figure 8.

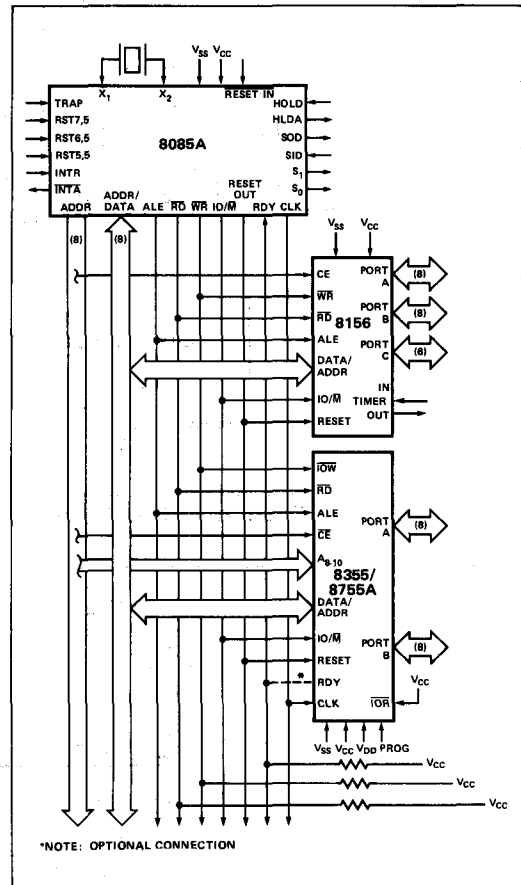

Figure 6. 8085A Minimum System (Standard I/O Technique)

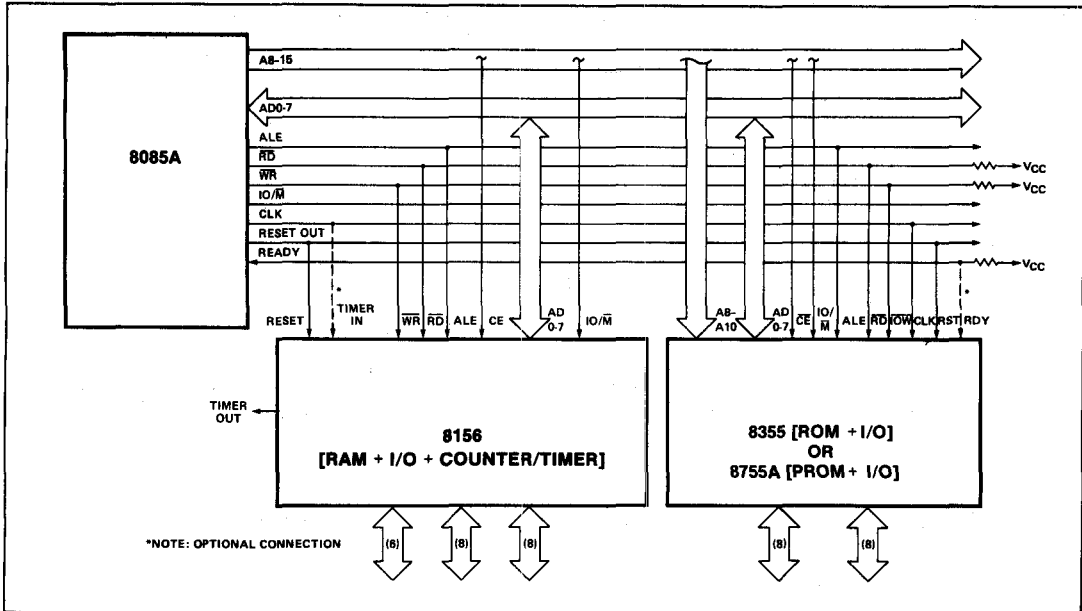

Figure 7. MCS-85™ Minimum System (Memory Mapped I/O)

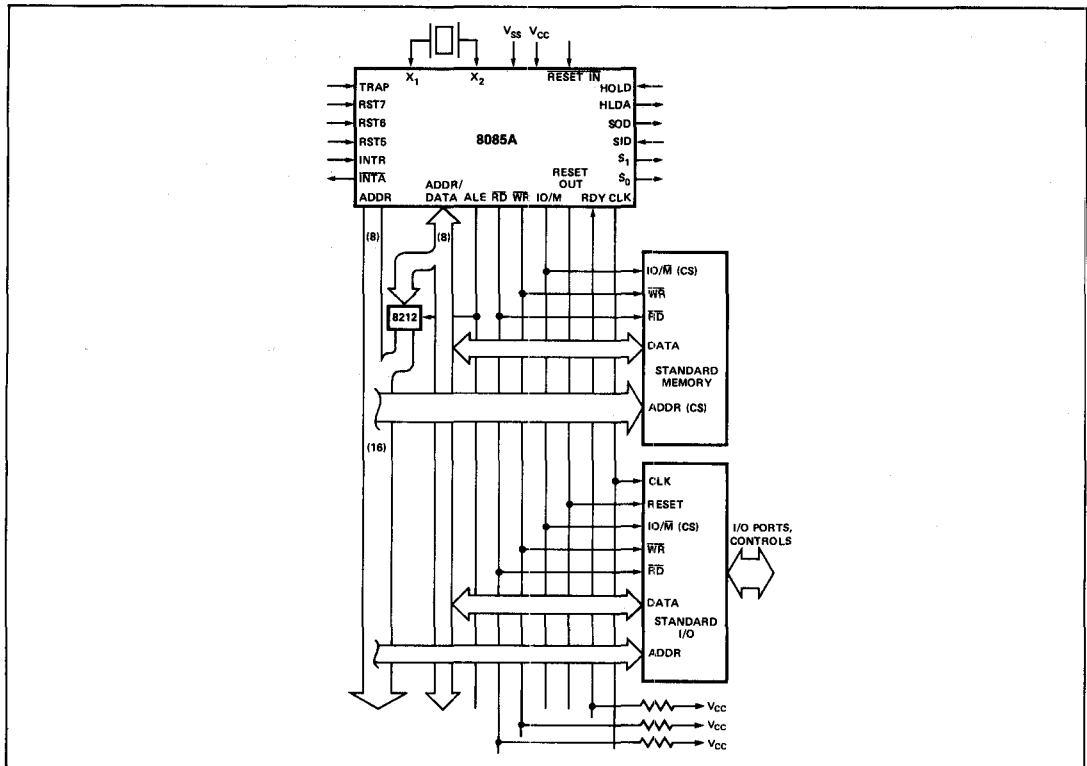

Figure 8. MCS-85™ System (Using Standard Memories)

BASIC SYSTEM TIMING

The 8085A has a multiplexed Data Bus. ALE is used as a strobe to sample the lower 8-bits of address on the Data Bus. Figure 9 shows an instruction fetch, memory read and I/O write cycle (as would occur during processing of the OUT instruction). Note that during the I/O write and read cycle that the I/O port address is copied on both the upper and lower half of the address.

There are seven possible types of machine cycles. Which of these seven takes place is defined by the status of the three status lines ($\overline{IO/\overline{M}}$, S_1 , S_0) and the three control signals (\overline{RD} , \overline{WR} , and \overline{INTA}). (See Table 3.) The status lines can be used as advanced controls (for device selection, for example), since they become active at the T_1 state, at the outset of each machine cycle. Control lines \overline{RD} and \overline{WR} become active later, at the time when the transfer of data is to take place, so are used as command lines.

A machine cycle normally consists of three T states, with the exception of OPCODE FETCH, which normally has either four or six T states (unless WAIT or HOLD states are forced by the receipt of READY or HOLD inputs). Any Tstate must be one of ten possible states, shown in Table 4.

Table 3. 8085A Machine Cycle Chart

MACHINE CYCLE	STATUS			CONTROL		
	$\overline{IO/\overline{M}}$	S_1	S_0	\overline{RD}	\overline{WR}	\overline{INTA}
OPCODE FETCH (OF)	0	1	1	0	1	1
MEMORY READ (MR)	0	1	0	0	1	1
MEMORY WRITE (MW)	0	0	1	1	0	1
I/O READ (IOR)	1	1	0	0	1	1
I/O WRITE (IOW)	1	0	1	1	0	1
ACKNOWLEDGE OF INTR (INA)	1	1	1	1	1	0
BUS IDLE (BI): DAD	0	1	0	1	1	1
ACK. OF RST, TRAP	1	1	1	1	1	1
HALT	TS	0	0	TS	TS	1

Table 4. 8085A Machine State Chart

Machine State	Status & Buses				Control		
	S_1, S_0	$\overline{IO/\overline{M}}$	A_8-A_{15}	AD_0-AD_7	$\overline{RD}, \overline{WR}$	\overline{INTA}	ALE
T_1	X	X	X	X	1	1	1*
T_2	X	X	X	X	X	X	0
T_{WAIT}	X	X	X	X	X	X	0
T_3	X	X	X	X	X	X	0
T_4	1	0†	X	TS	1	1	0
T_5	1	0†	X	TS	1	1	0
T_6	1	0†	X	TS	1	1	0
T_{RESET}	X	TS	TS	TS	TS	1	0
T_{HALT}	0	TS	TS	TS	TS	1	0
T_{HOLD}	X	TS	TS	TS	TS	1	0

0 = Logic "0"
 1 = Logic "1"
 TS = High Impedance
 X = Unspecified

* ALE not generated during 2nd and 3rd machine cycles of DAD instruction.
 † $\overline{IO/\overline{M}} = 1$ during T_4-T_6 of INA machine cycle.

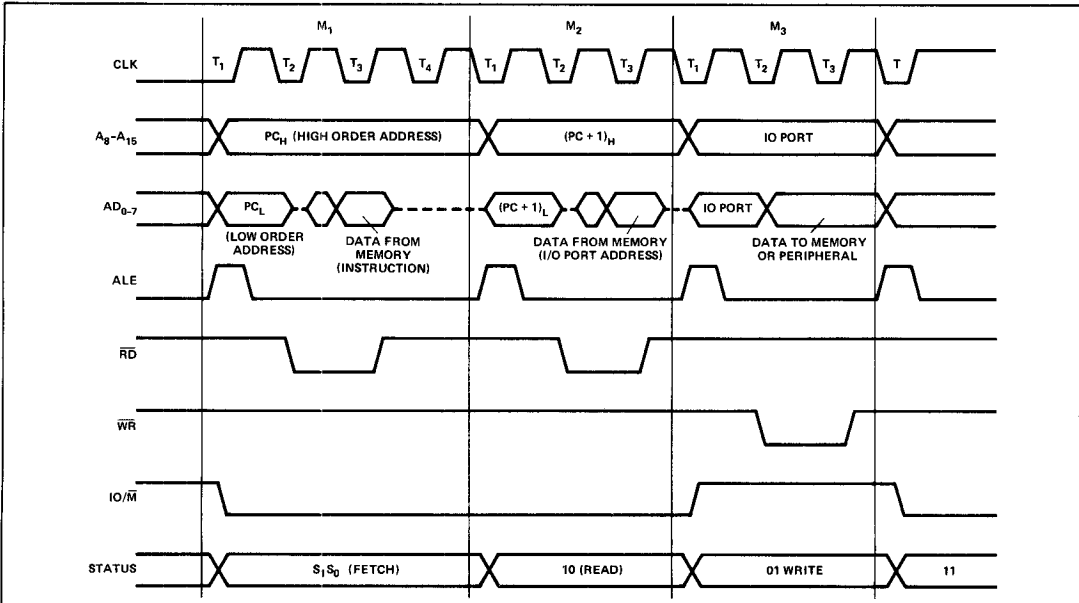

Figure 9. 8085A Basic System Timing

ABSOLUTE MAXIMUM RATINGS*

Ambient Temperature Under Bias 0°C to 70°C
 Storage Temperature -65°C to +150°C
 Voltage on Any Pin
 With Respect to Ground -0.5V to +7V
 Power Dissipation 1.5 Watt

**NOTICE: Stresses above those listed under "Absolute Maximum Ratings" may cause permanent damage to the device. This is a stress rating only and functional operation of the device at these or any other conditions above those indicated in the operational sections of this specification is not implied. Exposure to absolute maximum rating conditions for extended periods may affect device reliability.*

D.C. CHARACTERISTICS ($T_A = 0^\circ\text{C}$ to 70°C , $V_{CC} = 0\text{V} \pm 5\%$, $V_{SS} = 0\text{V}$; unless otherwise specified)

Symbol	Parameter	Min.	Max.	Units	Test Conditions
V_{IL}	Input Low Voltage	-0.5	+0.8	V	
V_{IH}	Input High Voltage	2.0	$V_{CC} + 0.5$	V	
V_{OL}	Output Low Voltage		0.45	V	$I_{OL} = 2\text{mA}$
V_{OH}	Output High Voltage	2.4		V	$I_{OH} = -400\mu\text{A}$
I_{CC}	Power Supply Current		170	mA	
I_{IL}	Input Leakage		± 10	μA	$0 \leq V_{IN} \leq V_{CC}$
I_{LO}	Output Leakage		± 10	μA	$0.45\text{V} \leq V_{out} \leq V_{CC}$
V_{ILR}	Input Low Level, RESET	-0.5	+0.8	V	
V_{IHR}	Input High Level, RESET	2.4	$V_{CC} + 0.5$	V	
V_{HY}	Hysteresis, RESET	0.25		V	

A.C. CHARACTERISTICS ($T_A = 0^\circ\text{C}$ to 70°C , $V_{CC} = 0\text{V} \pm 5\%$, $V_{SS} = 0\text{V}$)

Symbol	Parameter	8085A ^[2]		8085A-2 ^[2]		Units
		Min.	Max.	Min.	Max.	
t_{CYC}	CLK Cycle Period	320	2000	200	2000	ns
t_1	CLK Low Time (Standard CLK Loading)	80		40		ns
t_2	CLK High Time (Standard CLK Loading)	120		70		ns
t_r, t_f	CLK Rise and Fall Time		30		30	ns
t_{XKR}	X_1 Rising to CLK Rising	30	120	30	100	ns
t_{XKF}	X_1 Rising to CLK Falling	30	150	30	110	ns
t_{AC}	A_{8-15} Valid to Leading Edge of Control ^[1]	270		115		ns
t_{ACL}	A_{0-7} Valid to Leading Edge of Control	240		115		ns
t_{AD}	A_{0-15} Valid to Valid Data In		575		350	ns
t_{AFR}	Address Float After Leading Edge of READ (INTA)		0		0	ns
t_{AL}	A_{8-15} Valid Before Trailing Edge of ALE ^[1]	115		50		ns
t_{ALL}	A_{0-7} Valid Before Trailing Edge of ALE	90		50		ns
t_{ARY}	READY Valid from Address Valid		220		100	ns
t_{CA}	Address (A_{8-15}) Valid After Control	120		60		ns
t_{CC}	Width of Control Low (RD, WR, INTA) Edge of ALE	400		230		ns
t_{CL}	Trailing Edge of Control to Leading Edge of ALE	50		25		ns
t_{DW}	Data Valid to Trailing Edge of WRITE	420		230		ns
t_{HABE}	HLDA to Bus Enable		210		150	ns
t_{HABF}	Bus Float After HLDA		210		150	ns
t_{HACK}	HLDA Valid to Trailing Edge of CLK	110		40		ns
t_{HDH}	HOLD Hold Time	0		0		ns
t_{HDS}	HOLD Setup Time to Trailing Edge of CLK	170		120		ns
t_{INH}	INTR Hold Time	0		0		ns
t_{INS}	INTR, RST, and TRAP Setup Time to Falling Edge of CLK	160		150		ns
t_{LA}	Address Hold Time After ALE	100		50		ns
t_{LC}	Trailing Edge of ALE to Leading Edge of Control	130		60		ns
t_{LCK}	ALE Low During CLK High	100		50		ns
t_{LDR}	ALE to Valid Data During Read		460		270	ns
t_{LOW}	ALE to Valid Data During Write		200		120	ns
t_{LL}	ALE Width	140		80		ns
t_{LRY}	ALE to READY Stable		110		30	ns

A.C. CHARACTERISTICS (Continued)

Symbol	Parameter	8085A ^[2]		8085A-2 ^[2]		Units
		Min.	Max.	Min.	Max.	
t _{RAE}	Trailing Edge of $\overline{\text{READ}}$ to Re-Enabling of Address	150		90		ns
t _{RD}	$\overline{\text{READ}}$ (or $\overline{\text{INTA}}$) to Valid Data		300		150	ns
t _{RV}	Control Trailing Edge to Leading Edge of Next Control	400		220		ns
t _{RDH}	Data Hold Time After $\overline{\text{READ}}$ $\overline{\text{INTA}}$ ^[7]	0		0		ns
t _{RYH}	READY Hold Time	0		0		ns
t _{RYS}	READY Setup Time to Leading Edge of CLK	110		100		ns
t _{WD}	Data Valid After Trailing Edge of $\overline{\text{WRITE}}$	100		60		ns
t _{WDL}	LEADING Edge of $\overline{\text{WRITE}}$ to Data Valid		40		20	ns

NOTES:

1. A₈-A₁₅ address Specs apply to $\overline{\text{IO/M}}$, S₀, and S₁ except A₈-A₁₅ are undefined during T₄-T₆ of OF cycle whereas $\overline{\text{IO/M}}$, S₀, and S₁ are stable.
2. Test conditions: t_{CYC} = 320 ns (8085A)/200 ns (8085A-2); C_L = 150 pF.
3. For all output timing where C_L = 150 pF use the following correction factors:
 25 pF < C_L < 150 pF: -0.10 ns/pF
 150 pF < C_L < 300 pF: +0.30 ns/pF
4. Output timings are measured with purely capacitive load.
5. All timings are measured at output voltage V_L = 0.8V, V_H = 2.0V, and 1.5V with 20 ns rise and fall time on inputs.
6. To calculate timing specifications at other values of t_{CYC} use Table 7.
7. Data hold time is guaranteed under all loading conditions.

A.C. TESTING INPUT, OUTPUT WAVEFORM

A.C. TESTING LOAD CIRCUIT

Table 5. Bus Timing Specification as a T_{CYC} Dependent

8085A			
t_{AL}	—	$(1/2) T - 45$	MIN
t_{LA}	—	$(1/2) T - 60$	MIN
t_{LL}	—	$(1/2) T - 20$	MIN
t_{LCK}	—	$(1/2) T - 60$	MIN
t_{LC}	—	$(1/2) T - 30$	MIN
t_{AD}	—	$(5/2 + N) T - 225$	MAX
t_{RD}	—	$(3/2 + N) T - 180$	MAX
t_{RAE}	—	$(1/2) T - 10$	MIN
t_{CA}	—	$(1/2) T - 40$	MIN
t_{DW}	—	$(3/2 + N) T - 60$	MIN
t_{WD}	—	$(1/2) T - 60$	MIN
t_{CC}	—	$(3/2 + N) T - 80$	MIN
t_{CL}	—	$(1/2) T - 110$	MIN
t_{ARY}	—	$(3/2) T - 260$	MAX
t_{HACK}	—	$(1/2) T - 50$	MIN
t_{HABF}	—	$(1/2) T + 50$	MAX
t_{HABE}	—	$(1/2) T + 50$	MAX
t_{AC}	—	$(2/2) T - 50$	MIN
t_1	—	$(1/2) T - 80$	MIN
t_2	—	$(1/2) T - 40$	MIN
t_{RV}	—	$(3/2) T - 80$	MIN
t_{LDR}	—	$(4/2) T - 180$	MAX

NOTE: N is equal to the total WAIT states.

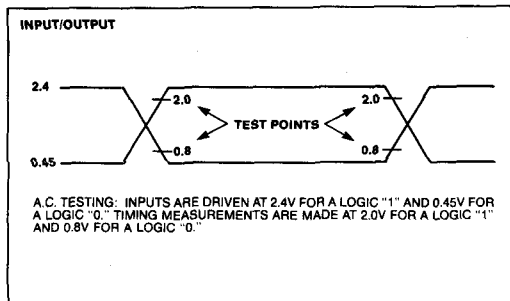
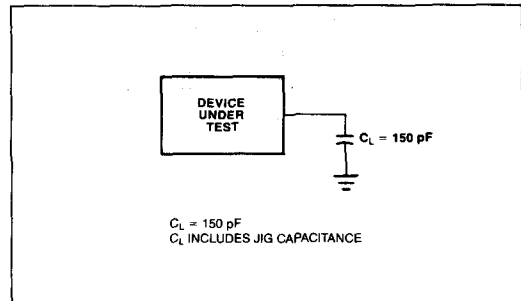
$$T = t_{CYC}$$

8085A-2			
t_{AL}	—	$(1/2) T - 50$	MIN
t_{LA}	—	$(1/2) T - 50$	MIN
t_{LL}	—	$(1/2) T - 20$	MIN
t_{LCK}	—	$(1/2) T - 50$	MIN
t_{LC}	—	$(1/2) T - 40$	MIN
t_{AD}	—	$(5/2 + N) T - 150$	MAX
t_{RD}	—	$(3/2 + N) T - 150$	MAX
t_{RAE}	—	$(1/2) T - 10$	MIN
t_{CA}	—	$(1/2) T - 40$	MIN
t_{DW}	—	$(3/2 + N) T - 70$	MIN
t_{WD}	—	$(1/2) T - 40$	MIN
t_{CC}	—	$(3/2 + N) T - 70$	MIN
t_{CL}	—	$(1/2) T - 75$	MIN
t_{ARY}	—	$(3/2) T - 200$	MAX
t_{HACK}	—	$(1/2) T - 60$	MIN
t_{HABF}	—	$(1/2) T + 50$	MAX
t_{HABE}	—	$(1/2) T + 50$	MAX
t_{AC}	—	$(2/2) T - 85$	MIN
t_1	—	$(1/2) T - 60$	MIN
t_2	—	$(1/2) T - 30$	MIN
t_{RV}	—	$(3/2) T - 80$	MIN
t_{LDR}	—	$(4/2) T - 130$	MAX

NOTE: N is equal to the total WAIT states.

$$T = t_{CYC}$$

WAVEFORMS

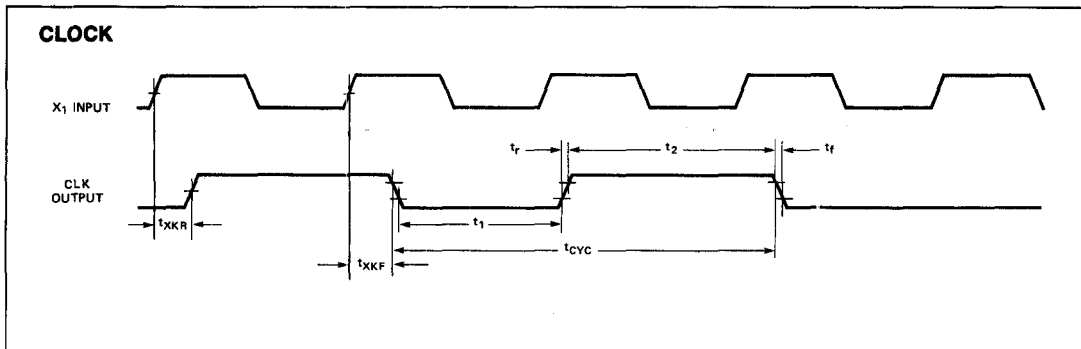

WAVEFORMS (Continued)

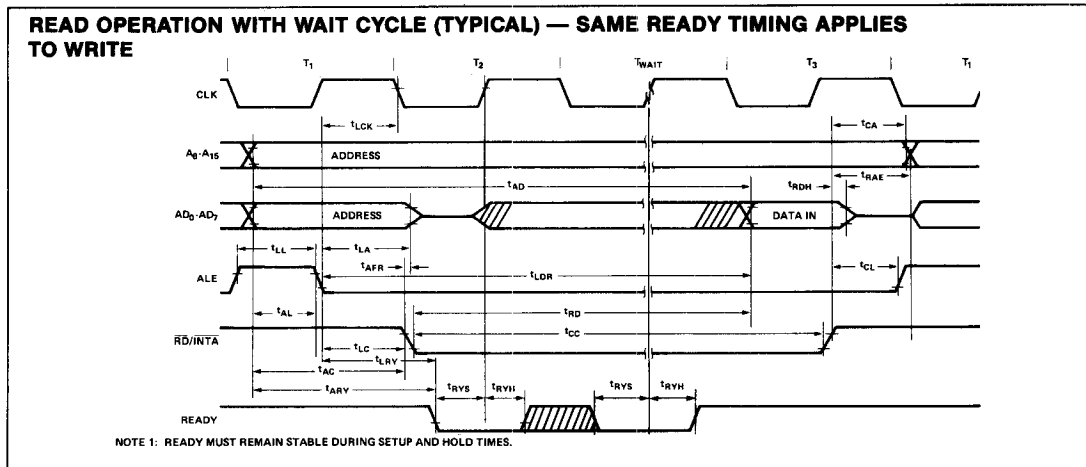
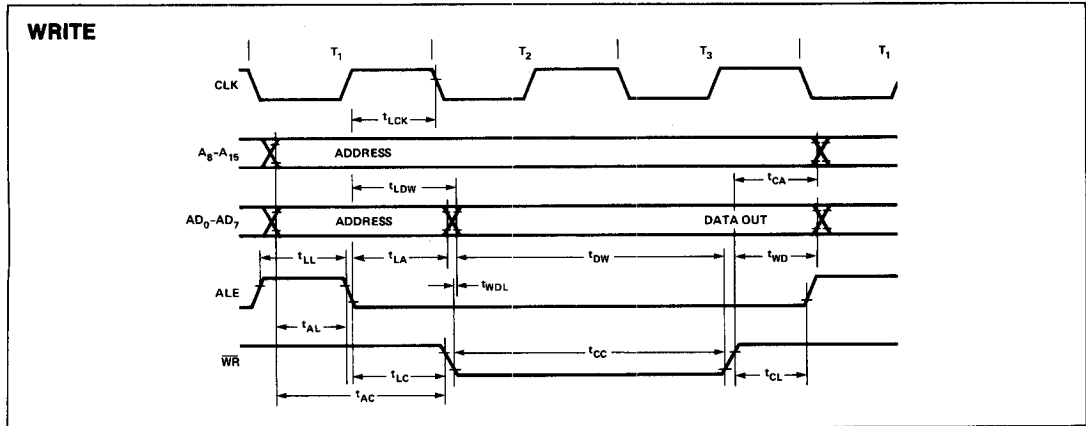
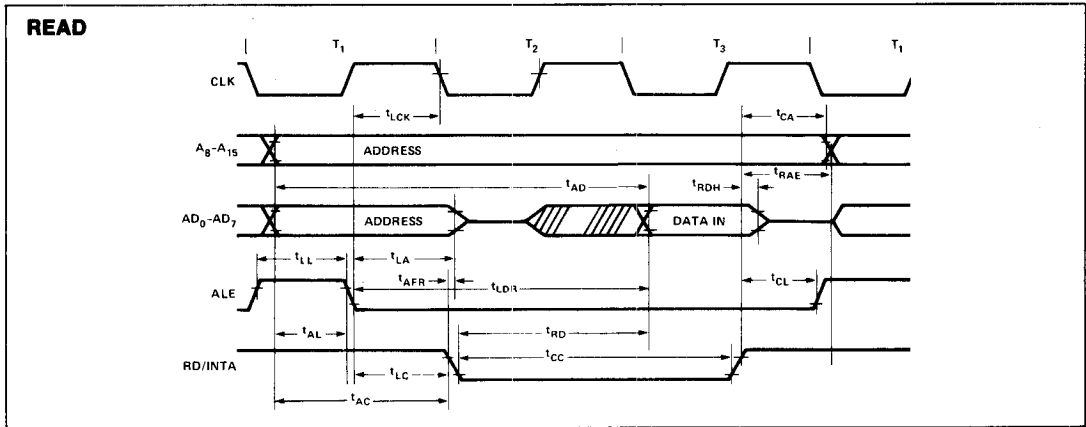

WAVEFORMS (Continued)

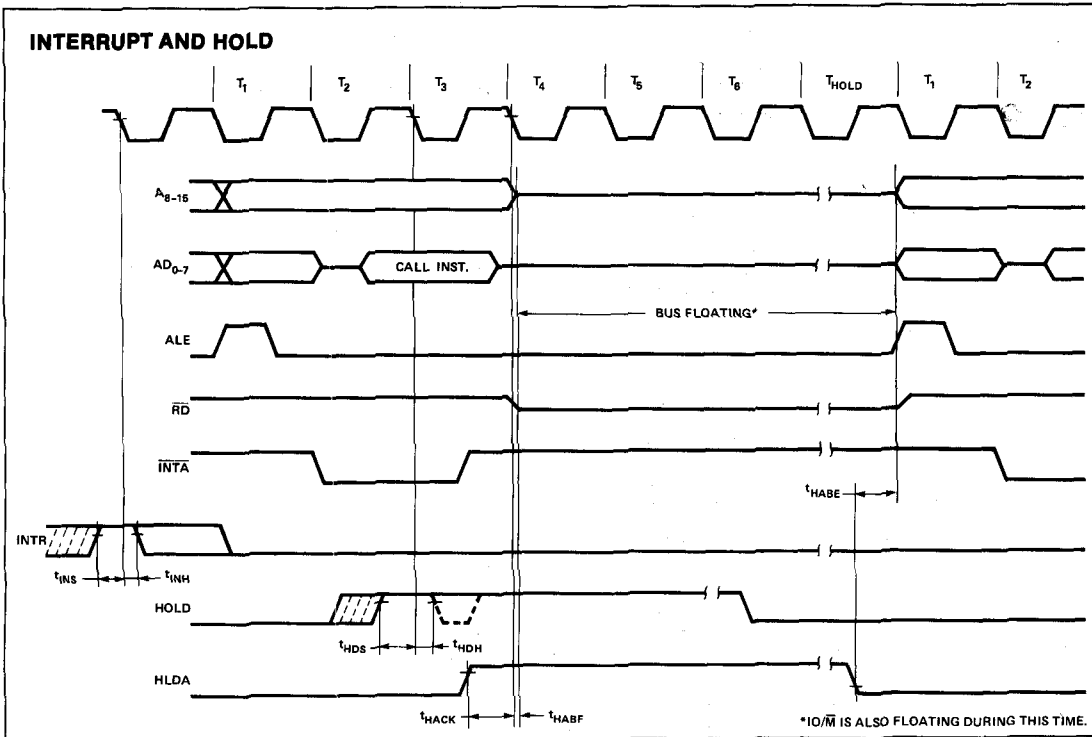
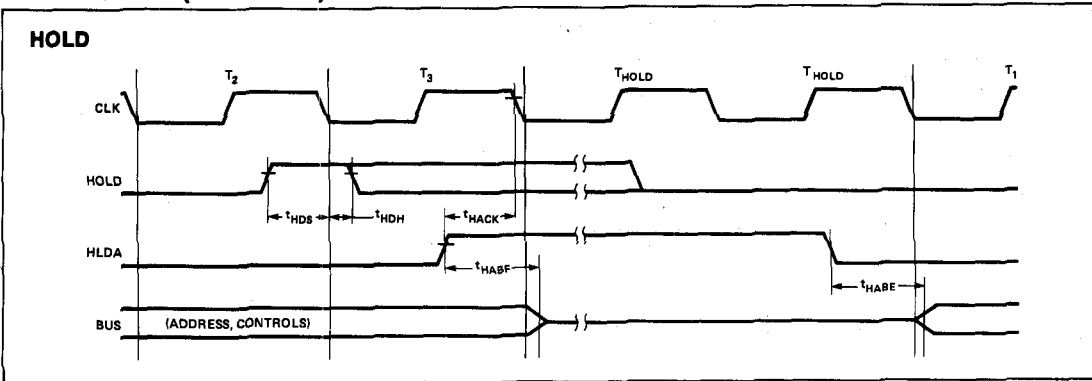

Table 6. Instruction Set Summary

Mnemonic	Instruction Code								Operations Description
	D ₇	D ₆	D ₅	D ₄	D ₃	D ₂	D ₁	D ₀	
MOVE, LOAD, AND STORE									
MOV r1 r2	0	1	D	D	D	S	S	S	Move register to register
MOV M.r	0	1	1	1	0	S	S	S	Move register to memory
MOV r.M	0	1	D	D	D	1	1	0	Move memory to register
MVI r	0	0	D	D	D	1	1	0	Move immediate register
MVI M	0	0	1	1	0	1	1	0	Move immediate memory
LXI B	0	0	0	0	0	0	0	1	Load immediate register Pair B & C
LXI D	0	0	0	1	0	0	0	1	Load immediate register Pair D & E
LXI H	0	0	1	0	0	0	0	1	Load immediate register Pair H & L
STAX B	0	0	0	0	0	0	1	0	Store A indirect
STAX D	0	0	0	1	0	0	1	0	Store A indirect
LDAX B	0	0	0	0	1	0	1	0	Load A indirect
LDAX D	0	0	0	1	1	0	1	0	Load A indirect
STA	0	0	1	1	0	0	1	0	Store A direct
LDA	0	0	1	1	1	0	1	0	Load A direct
SHLD	0	0	1	0	0	0	1	0	Store H & L direct
LHLD	0	0	1	0	1	0	1	0	Load H & L direct
XCHG	1	1	1	0	1	0	1	1	Exchange D & E, H & L Registers
STACK OPS									
PUSH B	1	1	0	0	0	1	0	1	Push register Pair B & C on stack
PUSH D	1	1	0	1	0	1	0	1	Push register Pair D & E on stack
PUSH H	1	1	1	0	0	1	0	1	Push register Pair H & L on stack
PUSH PSW	1	1	1	1	0	1	0	1	Push A and Flags on stack
POP B	1	1	0	0	0	0	0	1	Pop register Pair B & C off stack
POP D	1	1	0	1	0	0	0	1	Pop register Pair D & E off stack
POP H	1	1	1	0	0	0	0	1	Pop register Pair H & L off stack
POP PSW	1	1	1	1	0	0	0	1	Pop A and Flags off stack
XTHL	1	1	1	0	0	0	1	1	Exchange top of stack, H & L
SPHL	1	1	1	1	1	0	0	1	H & L to stack pointer
LXI SP	0	0	1	1	0	0	0	1	Load immediate stack pointer
INX SP	0	0	1	1	0	0	1	1	Increment stack pointer
DCX SP	0	0	1	1	1	0	1	1	Decrement stack pointer
JUMP									
JMP	1	1	0	0	0	0	1	1	Jump unconditional
JC	1	1	0	1	1	0	1	0	Jump on carry
JNC	1	1	0	1	0	0	1	0	Jump on no carry
JZ	1	1	0	0	1	0	1	0	Jump on zero
JNZ	1	1	0	0	0	0	1	0	Jump on no zero
JP	1	1	1	1	0	0	1	0	Jump on positive
JM	1	1	1	1	1	0	1	0	Jump on minus
JPE	1	1	1	0	1	0	1	0	Jump on parity even
JPO	1	1	1	0	0	0	1	0	Jump on parity odd
PCHL	1	1	1	0	1	0	0	1	H & L to program counter
CALL									
CALL	1	1	0	0	1	1	0	1	Call unconditional
CC	1	1	0	1	1	1	0	0	Call on carry
CNC	1	1	0	1	0	1	0	0	Call on no carry

Mnemonic	Instruction Code								Operations Description
	D ₇	D ₆	D ₅	D ₄	D ₃	D ₂	D ₁	D ₀	
CZ	1	1	0	0	1	1	0	0	Call on zero
CNZ	1	1	0	0	0	1	0	0	Call on no zero
CP	1	1	1	1	0	1	0	0	Call on positive
CM	1	1	1	1	1	1	0	0	Call on minus
CPE	1	1	1	0	1	1	0	0	Call on parity even
CPO	1	1	1	0	0	1	0	0	Call on parity odd
RETURN									
RET	1	1	0	0	1	0	0	1	Return
RC	1	1	0	1	1	0	0	0	Return on carry
RNC	1	1	0	1	0	0	0	0	Return on no carry
RZ	1	1	0	0	1	0	0	0	Return on zero
RNZ	1	1	0	0	0	0	0	0	Return on no zero
RP	1	1	1	1	0	0	0	0	Return on positive
RM	1	1	1	1	1	0	0	0	Return on minus
RPE	1	1	1	0	1	0	0	0	Return on parity even
RPO	1	1	1	0	0	0	0	0	Return on parity odd
RESTART									
RST	1	1	A	A	A	1	1	1	Restart
INPUT/OUTPUT									
IN	1	1	0	1	1	0	1	1	Input
OUT	1	1	0	1	0	0	1	1	Output
INCREMENT AND DECREMENT									
INR r	0	0	D	D	D	1	0	0	Increment register
DCR r	0	0	D	D	D	1	0	1	Decrement register
INR M	0	0	1	1	0	1	0	0	Increment memory
DCR M	0	0	1	1	0	1	0	1	Decrement memory
INX B	0	0	0	0	0	0	1	1	Increment B & C registers
INX D	0	0	0	1	0	0	1	1	Increment D & E registers
INX H	0	0	1	0	0	0	1	1	Increment H & L registers
DCX B	0	0	0	0	1	0	1	1	Decrement B & C
DCX D	0	0	0	1	1	0	1	1	Decrement D & E
DCX H	0	0	1	0	1	0	1	1	Decrement H & L
ADD									
ADD r	1	0	0	0	0	S	S	S	Add register to A
ADC r	1	0	0	0	1	S	S	S	Add register to A with carry
ADD M	1	0	C	0	0	1	1	0	Add memory to A
ADC M	1	0	0	0	1	1	1	0	Add memory to A with carry
ADI	1	1	0	0	0	1	1	0	Add immediate to A
ACI	1	1	0	0	1	1	1	0	Add immediate to A with carry
DAD B	0	0	0	0	1	0	0	1	Add B & C to H & L
DAD D	0	0	0	1	1	0	0	1	Add D & E to H & L
DAD H	0	0	1	0	1	0	0	1	Add H & L to H & L
DAD SP	0	0	1	1	1	0	0	1	Add stack pointer to H & L
SUBTRACT									
SUB r	1	0	0	1	0	S	S	S	Subtract register from A
SBB r	1	0	0	1	1	S	S	S	Subtract register from A with borrow
SUB M	1	0	0	1	0	1	1	0	Subtract memory from A
SBB M	1	0	0	1	1	1	1	0	Subtract memory from A with borrow
SUI	1	1	0	1	0	1	1	0	Subtract immediate from A
SBI	1	1	0	1	1	1	1	0	Subtract immediate from A with borrow

Table 6-1. Instruction Set Summary (Cont'd)

Mnemonic	Instruction Code							Operations Description	Mnemonic	Instruction Code							Operations Description
	D ₇	D ₆	D ₅	D ₄	D ₃	D ₂	D ₁			D ₀	D ₇	D ₆	D ₅	D ₄	D ₃	D ₂	
LOGICAL																	
ANA r	1	0	1	0	0	S	S	S	And register with A								
XRA r	1	0	1	0	1	S	S	S	Exclusive OR register with A								
ORA r	1	0	1	1	0	S	S	S	OR register with A								
CMP r	1	0	1	1	1	S	S	S	Compare register with A								
ANA M	1	0	1	0	0	1	1	0	And memory with A								
XRA M	1	0	1	0	1	1	1	0	Exclusive OR memory with A								
ORA M	1	0	1	1	0	1	1	0	OR memory with A								
CMP M	1	0	1	1	1	1	1	0	Compare memory with A								
ANI	1	1	1	0	0	1	1	0	And immediate with A								
XRI	1	1	1	0	1	1	1	0	Exclusive OR immediate with A								
ORI	1	1	1	1	0	1	1	0	OR immediate with A								
CPI	1	1	1	1	1	1	1	0	Compare immediate with A								
ROTATE																	
RLC	0	0	0	0	0	1	1	1	Rotate A left								
RRC	0	0	0	0	1	1	1	1	Rotate A right								
RAL	0	0	0	1	0	1	1	1	Rotate A left through carry								
RAR	0	0	0	1	1	1	1	1	Rotate A right through carry								
SPECIALS																	
CMA	0	0	1	0	1	1	1	1	Complement A								
STC	0	0	1	1	0	1	1	1	Set carry								
CMC	0	0	1	1	1	1	1	1	Complement carry								
DAA	0	0	1	0	0	1	1	1	Decimal adjust A								
CONTROL																	
EI	1	1	1	1	1	0	1	1	Enable Interrupts								
DI	1	1	1	1	0	0	1	1	Disable Interrupt								
NOP	0	0	0	0	0	0	0	0	No-operation								
HLT	0	1	1	1	0	1	1	0	Halt								
NEW 8085A INSTRUCTIONS																	
RIM	0	0	1	0	0	0	0	0	Read Interrupt Mask								
SIM	0	0	1	1	0	0	0	0	Set Interrupt Mask								

NOTES:

1. DDS or SSS: B 000, C 001, D 010, E011, H 100, L 101, Memory 110, A 111.
2. Two possible cycle times (8/12) indicate instruction cycles dependent on condition flags.

*All mnemonics copyrighted ©Intel Corporation 1976.